



PROGRAMMÜBERSICHT
PROGRAM OVERVIEW
2020



DUSCHSYSTEME | SHOWER SYSTEMS



Philosophie	Philosophy	4	Produktzertifizierung	Product certification	58
Duschsysteme	Shower systems	6	Ausstellungsmodule	Demonstration modules	60
Sonderlösungen	Special solutions	34	Funktionsübersicht	Overview of functions	62
Saunalösungen	Sauna solutions	40	Einbausituationen	Installation situations	64
Sonderoberflächen	Special surfaces	42	E-Commerce	E-Commerce	70
Zubehör & Details	Accessories & Details	44	Seminarprogramm	Training Programm	71

Erleben Sie gral Duschsysteme Experience gral shower systems

Besuchen Sie unseren Showroom in Rietberg

gral Duschsysteme können Sie in unserer großen Ausstellung im ostwestfälischen Rietberg live erleben – in verschiedenen Ambientes, in vielfältigen Einbausituationen und in der Kombination mit diversen Glasdesigns.

Lassen Sie sich inspirieren – vereinbaren Sie bitte einen Besuchstermin unter Telefon +49 (0) 5244 90 76-0.

Come and visit our showroom in Rietberg, Germany

gral shower systems can be seen at first hand in our showroom in Rietberg in the north-west of Germany. They are displayed in various environments and installation situations, as well as in combination with a wide range of glass designs.

Discover inspiration. Simply phone us to arrange a time to visit: +49 (0) 5244 90 76-0.

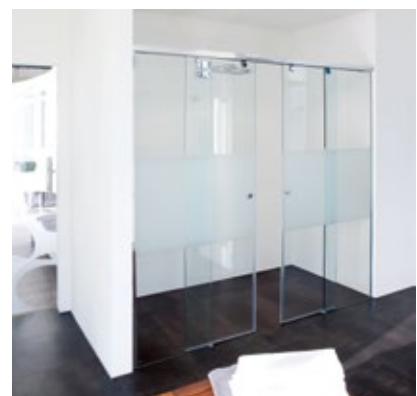

Wertigkeit, die den Unterschied macht

Making a difference through added value



Erstklassige Produkt- und Verarbeitungsqualität

Produkte von gral stehen für deutsche Wertarbeit mit der Garantie auf eine lange Lebenszeit. Hochqualifizierte manuelle Fertigungstechniken und Hightech-Verfahren wie CNC Fräsen/Drehen gehen dabei Hand in Hand.

First-class product quality and workmanship

Products from gral epitomize German craftsmanship with the guarantee of long service lifetimes. Exceptional manual production skills interlink with high-tech processes such as CNC milling/turning.



Hochwertige Beschläge aus massivem Messing

Die Grundlage für die hochwertige Oberflächengüte der gral Produkte bildet massives Messing, dessen mechanische Stabilität die hervorragenden Funktionen der Befestigungssysteme sichert.

High-quality fittings of solid brass

Providing the basis for the high-quality finish common to all gral products, solid brass exhibits the mechanical stability to ensure supreme assembly functionality.

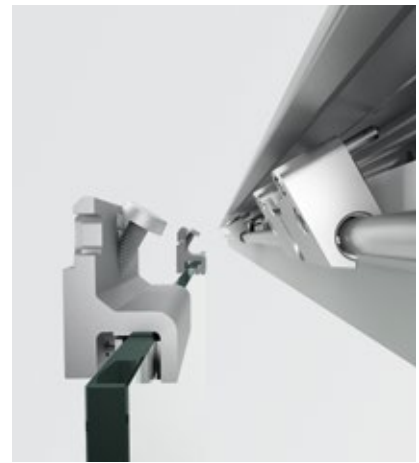

Innovativ konzipierte Beschlagssysteme

Neue Montage-/Befestigungsmethoden, etwa die einfach einzuhängende und einstellbare SF 740 Schiebetür (siehe Foto), weisen wie die einheitliche Designverbund-Serie 112 (BF/BO/BH) für unterschiedliche Funktionen den Weg in die nächste Produktgeneration.

Innovative fittings and accessories

New mounting/fixing techniques, as applied to the easy-to-hang and adjust SF 740 sliding door (see photo), and the advent of the integrated design series 112 (BF/BO/BH), are in the vanguard of our next-generation product solutions for a wide range of applications and functions.

Von der Idee bis hin zur Konzeption – Seit fast 30 Jahren entwickelt, produziert und vertreibt das Unternehmen aus Rietberg technologisch, qualitativ und ästhetisch herausragende Beschläge und Systeme für Duschtrennungen und Duschkabinen für zeitgemäße Bäder anspruchsvoller Ein- und Mehrfamilienhäuser, Wohnanlagen, Hotels und Kliniken.

From the idea to the conception – For almost 30 years the company, now based in Rietberg, has been developing, producing and selling technologically, qualitatively and aesthetically outstanding fittings and systems for shower enclosures and cubicles for modern bathrooms in sophisticated single and multiple family homes, residential complexes, hotels and clinics.

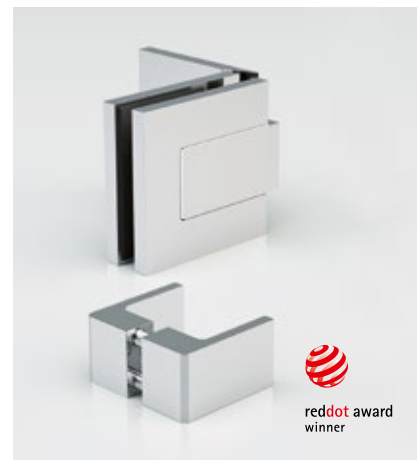

Außergewöhnliche Vielfalt an Oberflächen »Colour Edition«

Egal, ob glänzend oder matt, poliert oder unpoliert (antik), farbeschichtet oder sondereloxiert, gral bietet Sonderoberflächen für jeden Einrichtungsstil.

Exceptional choice of surfaces »Colour Edition«

Whether bright or satinized, polished or matt (antique look), color-coated or custom-anodized, gral offers special surfaces to suit any interior style.

Montagefreundlich und langlebig

Leicht verständliche Montageanleitungen und eine 6-jährige Garantie stehen für mühelosen Einbau und lange Benutzerfreude.

Easy to install and thoroughly durable

Readily comprehensible mounting instructions and a 6-year warranty for peace of mind.

Design-Auszeichnung Duschbeschlagserie BF 112

Die Pendeltürserie BF 112 ist u. a. für Design, Funktionalität, Ergonomie und Innovationsgrad mit dem reddot Award ausgezeichnet worden.

Design award shower fitting series BF 112

The double-action door serie BF 112 received the reddot Award for their design, functionality, ergonomic efficiency and innovative content.



6 JAHRE GARANTIE
YEARS WARRANTY
** long life product **



Keine Dusche ist wie die andere

Die individuellen Wünsche an die richtige Dusche sind so vielfältig wie die baulichen Voraussetzungen im Bad. Mit der großen Auswahl an Funktionsbeschlägen von gral lässt sich praktisch jede persönliche Traumdusche verwirklichen – ob mit Hebe-/Senk- oder Pendelmechanik, als Schiebetür, Anschlagtür, Falt- oder Walk-In Lösung, punktgehalten oder geklemmt.

Every shower is different

Individual requirements for the ideal shower are as diverse as the layouts of bathrooms themselves. With the wide range of gral functional fittings, almost any dream shower can be realized – whether with a rising or double-action mechanism, sliding or swing door, single-point fixing or clamp fittings, or as a folding-door or walk-in solution.



ANSCHLAGTÜRSYSTEME
SINGLE-ACTION DOOR SYSTEMS

8



BO 112 BO 410 BO 415 BO 450



ANSCHLAGTÜRSYSTEME MIT HEBE-SENK-FUNKTION
SINGLE-ACTION DOOR SYSTEMS WITH LIFT-LOWER-FUNKTION

12



BH 112 BH 200 BH 205 BH 210 BH 250 BH 255



PENDELTÜRSYSTEME
DOUBLE-ACTION DOOR SYSTEMS

16



BO 381 BF 111 BF 112 BF 112 XL BF 134



PENDELTÜRSYSTEME MIT HEBE-SENK-FUNKTION
DOUBLE-ACTION DOOR SYSTEMS WITH LIFT-LOWER-FUNKTION

20



BH 2401



Glasstärke
Glass thickness



einstellbare Nullstellung
adjustable zero positioning



max. Tragfähigkeit (2 Bänder)
max. loading capacity (2 hinges)



Soft-Stop
Soft-Stop



Glasbefestigung mit Gegenplatte
Glass fixing with counterplate



Soft-Einzug
Soft-Closing



Glasbefestigung flächenbündig
Countersunk glass fixing



Sauna geeignet bis 90°
Sauna suitable 90 degrees



Glasbefestigung verschweißt
Glass fixing strength-welded



FALTTÜRSYSTEME
FOLDING DOOR SYSTEMS

22



BF 112



BF 112 XL



BF 134



BO 450



SCHIEBETÜRSYSTEME
SLIDING DOOR SYSTEMS

26



SO 730

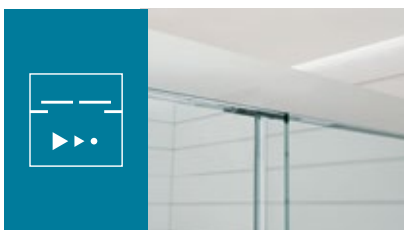

SCHIEBETÜRSYST. MIT DÄMPFUNGS- UND EINZUGSFUNKTION
SLIDING DOOR SYS. WITH DAMPING AND SELF-CLOSING FUNCTION

28



SF 740
PREMIUM



WALK-IN SYSTEME
WALK-IN SYSTEMS

30



WINKEL
BRACKET



PROFIL
PROFILE



PO 570



VARIANT



ANSCHLAGTÜRSYSTEME SINGLE-ACTION DOOR SYSTEMS

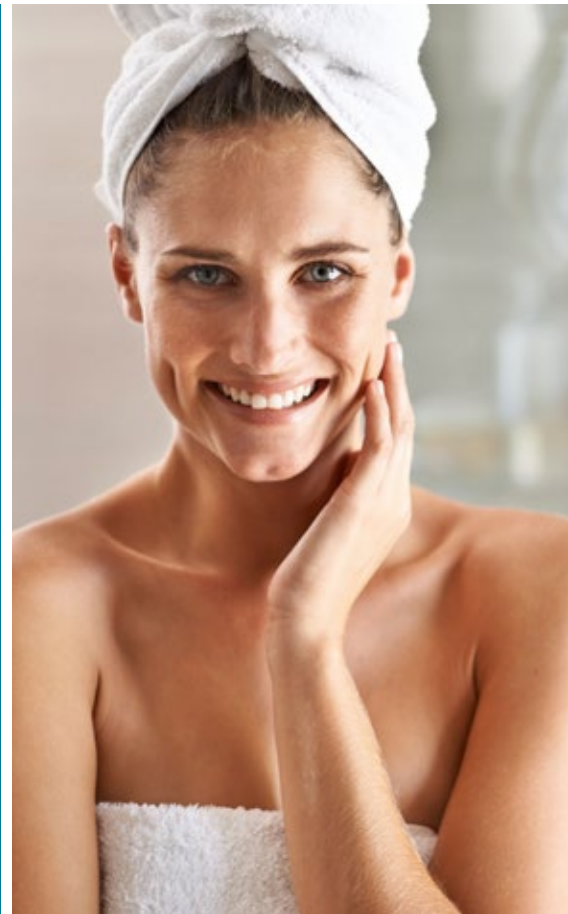

Der Klassiker unter den Duschsystemen. Anschlagtürsysteme mit Glas/Wand- oder Glas/Glas Beschlägen ohne Zusatzfunktion finden größtenteils Anwendung bei Glasduschen mit Duschtasse in normalgroßen Badezimmern, wo die Flügeltüren problemlos ausschließlich einseitig nach außen geöffnet werden können.

The classic among shower systems. Hinged door systems with glass/wall or glass/glass fittings without additional function are mainly used for glass showers with shower tray in normal sized bathrooms, where the hinged doors can be opened outwards on one side only without any problems.

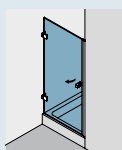

100

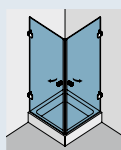

120

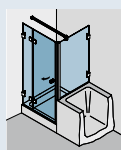

231W/P

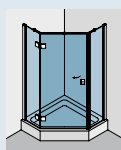

255W/P

Hier sehen Sie nur eine kleine Auswahl möglicher Einbauvarianten. Alle mit dem System realisierbaren Einbausituationen finden Sie ab Seite 64.

Here are a few installation examples. All realizable system installation situations see from page 64.

BO 112

Anschlagtürsystem

- nach außen öffnend
- durchgehende Dichtungen an allen Glaskanten
- Verschraubungen verdeckt
- vielfältige Varianten

Single-action door system

- outward opening
- continuous seals along all glass edges
- concealed screw connections
- wide range of fittings



1



2



3

1 Band Glas/Wand
hinge glass/wall

2 Band Glas/Wand (innen)
hinge glass/wall (inside)

3 Band Glas/Glas 180°
hinge glass/glass 180°

BO 410

Anschlagtürsystem

- nach außen öffnend
- fluchtende und überlappende Türbeschläge
- durchgehende Dichtungen an allen Glaskanten
- Verschraubungen verdeckt
- vielfältige Varianten

Single-action door system

- outward opening
- flush and overlapping door fittings
- continuous seals along all glass edges
- concealed screw connections
- wide range of fittings



1



2



3

1 Band Glas/Wand
hinge glass/wall

2 Band Glas/Glas 180°
hinge glass/glass 180°

3 Band Glas/Glas 180° (innen)
hinge glass/glass 180° (inside)



BO 415

Anschlagtürsystem

- nach außen öffnend
- fluchtende und überlappende Türbeschläge
- durchgehende Dichtungen an allen Glaskanten
- Verschraubungen verdeckt
- vielfältige Varianten

Single-action door system

- outward opening
- flush and overlapping door fittings
- continuous seals along all glass edges
- concealed screw connections
- wide range of fittings



1



2



3

1 Band Glas/Wand
hinge glass/wall

2 Band Glas/Glas 180°
hinge glass/glass 180°

3 flächenbündige Glasbefestigung
countersunk glass fixing

BO 450

Anschlagtürsystem

- nach außen öffnend
- durchgehende Dichtungen an allen Glaskanten
- Verschraubungen verdeckt
- auch für Falttüren (siehe Seite 24)

Single-action door system

- outward opening
- continuous seals along all glass edges
- concealed screw connections
- for folding doors as well (see page 24)



1



2



3

1 Band Glas/Wand
hinge glass/wall

2 Band Glas/Glas 180°
hinge glass/glass 180°

3 flächenbündige Glasbefestigung
countersunk glass fixing



BO 112 Typ(e) 110W

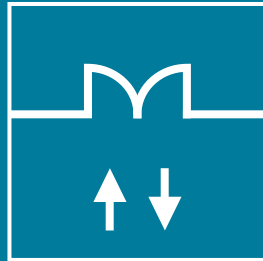

ANSCHLAGTÜRSYSTEME MIT HEBE-SENK-FUNKTION SINGLE-ACTION DOOR SYSTEMS WITH LIFT-LOWER-FUNKTION



Anschlagtürsysteme mit Hebe-Senk-Funktion sind bestens für barrierefreie, bodeneben begehbare Glasduschen geeignet, die bei Bauherren und Architekten hoch im Kurs stehen. Die stabilen Beschläge heben die Türen beim Öffnen um einige Millimeter an – die unteren Dichtungen werden geschont, da sie dann keinen Bodenkontakt haben.

Hinged door systems with a lift-lower function are ideally suited for barrier-free glass showers that can be walked on at floor level, which are very popular with building owners and architects. The stable fittings lift the door(s) by a few millimeters when opened – the lower seals are protected as they then have no contact with the floor.

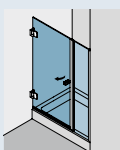

110W/P

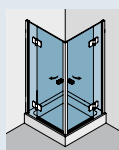

220W/P

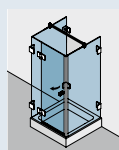

233W/P

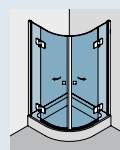

260W/P

Hier sehen Sie nur eine kleine Auswahl möglicher Einbauvarianten. Alle mit dem System realisierbaren Einbausituationen finden Sie ab Seite 65.

Here are a few installation examples. All realizable system installation situations see from page 65.

BH 112

Anschlagtürsystem

- nach außen öffnend
- Hebe-Senk (+/-5 mm)
- selbstschließend ab 90°
- durchgehende Dichtungen an allen Glaskanten
- Verschraubungen verdeckt
- vielfältige Varianten

Single-action door system

- outward opening
- lift-lower (+/-5 mm)
- self-closing from 90°
- continuous seals along all glass edges
- concealed screw connections
- wide range of fittings



1 Band Glas/Wand
hinge glass/wall

2 Band Glas/Wand (innen)
hinge glass/wall (inside)

3 Band Glas/Glas 180°
hinge glass/glass 180°

BH 200

Anschlagtürsystem

- nach außen öffnend
- Hebe-Senk (+/-5 mm)
- selbstschließend ab 90°
- durchgehende Dichtungen an allen Glaskanten
- Verschraubungen verdeckt

Single-action door system

- outward opening
- lift-lower (+/-5 mm)
- self-closing from 90°
- continuous seals along all glass edges
- concealed screw connections



1 Band Glas/Wand
hinge glass/wall

2 Band Glas/Glas 180°
hinge glass/glass 180°

3 Band Glas/Glas 180° (innen)
hinge glass/glass 180° (inside)



BH 205

Anschlagtürsystem

- nach außen öffnend
- Hebe-Senk (+/-5 mm)
- selbstschließend ab 90°
- durchgehende Dichtungen an allen Glaskanten
- Verschraubungen verdeckt

Single-action door system

- outward opening
- lift-lower (+/-5 mm)
- self-closing from 90°
- continuous seals along all glass edges
- concealed screw connections



1



2



3

1 Band Glas/Wand
hinge glass/wall

2 Band Glas/Glas 180°
hinge glass/glass 180°

3 flächenbündige Glasbefestigung
countersunk glass fixing

BH 210

Anschlagtürsystem

- nach außen öffnend
- Glasbefestigung verschweißt (statt verschraubt)
- Hebe-Senk (+/-5 mm)
- selbstschließend ab 30°
- Verschraubungen verdeckt
- wartungsfrei (Beschläge)

Single-action door system

- outward opening
- glass fixing strength-welded (instead of screwed)
- lift-lower (+/-5 mm)
- self-closing from 30°
- concealed screw connections
- maintenance-free (fittings)



1



2



3

1 Band Glas/Wand
hinge glass/wall

2 Band Glas/Glas 180°
hinge glass/glass 180°

3 durchg. Glasoberfläche (innen)
consistent glass surface (inside)

BH 250

Anschlagtürsystem

- nach außen öffnend
- Hebe-Senk (+/-5 mm)
- selbstschließend ab 90°
- durchgehende Dichtungen an allen Glaskanten
- Verschraubungen verdeckt
- minimalistisch

Single-action door system

- outward opening
- lift-lower (+/-5 mm)
- self-closing from 90°
- continuous seals along all glass edges
- concealed screw connections
- minimalistic



1 Band Glas/Wand
hinge glass/wall

2 Band Glas/Glas 180°
hinge glass/glass 180°

3 flächenbündige Glasbefestigung
countersunk glass fixing

BH 255

Anschlagtürsystem

- nach außen öffnend
- Hebe-Senk (+/-5 mm)
- selbstschließend ab 90°
- durchgehende Dichtungen an allen Glaskanten
- Verschraubungen verdeckt
- minimalistisch

Single-action door system

- outward opening
- lift-lower (+/-5 mm)
- self-closing from 90°
- continuous seals along all glass edges
- concealed screw connections
- minimalistic



1 Band Glas/Wand
hinge glass/wall

2 Band Glas/Glas 180°
hinge glass/glass 180°

3 Band Glas/Glas 180° (innen)
hinge glass/glass 180° (inside)



PENDELTÜRSYSTEME DOUBLE-ACTION DOOR SYSTEMS



Glasduschen mit Pendeltüren lassen sich bequem sowohl nach innen als auch nach außen öffnen und ermöglichen so jederzeit einen komfortablen Einstieg. Sie kommen aber nicht nur in großzügig dimensionierten Badezimmern zum Einsatz, sondern auch dort, wo die Raum- oder Duschengröße nur eine Öffnung nach innen erlaubt.

Glass showers with double-action doors can be opened easily both inwards and outwards, allowing easy access at any time. However, they are not only used in generously dimensioned bathrooms, but also where the size of the room or shower only allows an opening to the inside.

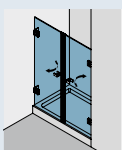

105

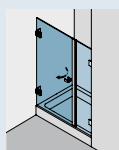

110W/P

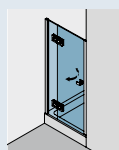

200W/P

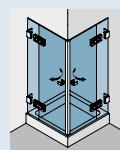

220W/P

Hier sehen Sie nur eine kleine Auswahl möglicher Einbauvarianten. Alle mit dem System realisierbaren Einbausituationen finden Sie ab Seite 66.

Here are a few installation examples. All realizable system installation situations see from page 66.

BO 381

Pendeltürsystem

- nach innen/außen öffnend
- Türbeschläge ohne Federmechanismus
- inkl. Anschlagschutz
- durchgehende Dichtungen beim Glas/Glas-Beschlag
- Verschraubungen verdeckt

Double-action door system

- inward/outward opening
- door fittings without spring mechanism
- integrated impact protector
- continuous seals by glass/glass fittings
- concealed screw connections



- 1 Band Glas/Wand
hinge glass/wall
- 2 Band Glas/Glas 180°
hinge glass/glass 180°
- 3 fächerbündige Glasbefestigung
countersunk glass fixing

BF 111

Pendeltürsystem

- nach innen/außen öffnend
- Türbeschläge mit Federmechanismus
- einstellbare Nullstellung
- selbstschließend ab 20°
- vielfältige Varianten

Double-action door system

- inward/outward opening
- door fittings with spring mechanism
- adjustable zero positioning
- self-closing from 20°
- wide range of fittings



- 1 Band Glas/Wand
hinge glass/wall
- 2 Band Glas/Glas 180°
hinge glass/glass 180°
- 3 Band Glas/Glas 90°
hinge glass/glass 90°



BF 112



Pendeltürsystem

- nach innen/außen öffnend
- Türbeschläge mit Federmechanismus
- einstellbare Nullstellung
- selbstschließend ab 20°
- Verschraubungen verdeckt
- vielfältige Varianten

Double-action door system

- inward/outward opening
- door fittings with spring mechanism
- adjustable zero positioning
- self-closing from 20°
- concealed screw connections
- wide range of fittings



1



2



3

1 Band Glas/Wand
hinge glass/wall

2 Band Glas/Glas 180°
hinge glass/glass 180°

3 Band Glas/Glas 90°
hinge glass/glass 90°

BF 112 XL

Pendeltürsystem

- nach innen/außen öffnend
- Türbeschläge mit Federmechanismus
- für XL-Abmessungen
- einstellbare Nullstellung
- selbstschließend ab 20°
- Verschraubungen verdeckt

Double-action door system

- inward/outward opening
- door fittings with spring mechanism
- for XL-dimensions
- adjustable zero positioning
- self-closing from 20°
- concealed screw connections



1



2



3

1 Band Glas/Wand XL
hinge glass/wall XL

2 Band Glas/Wand XL
hinge glass/wall XL

3 Band Glas/Glas 180° XL
hinge glass/glass 180° XL



BF 134

Pendeltürsystem

- nach innen/außen öffnend
- Türbeschläge mit Federmechanismus
- selbstschließend ab 20°
- vielfältige Varianten
- T-Beschläge für Reihenanlagen (siehe Seite 35)

Double-action door system

- inward/outward opening
- door fittings with spring mechanism
- self-closing from 20°
- wide range of fittings
- T-fittings for in-line cubicles (see page 35)



1



2



3

1 Band Glas/Wand
hinge glass/wall

2 Band Glas/Glas 180°
hinge glass/glass 180°

3 Band Glas/Glas 90°
hinge glass/glass 90°

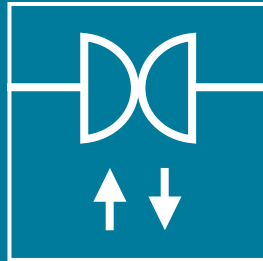

PENDELTÜRSYSTEME
MIT HEBE-SENK-FUNKTION
DOUBLE-ACTION DOOR SYSTEMS
WITH LIFT-LOWER-FUNKTION



Die Weiterentwicklung der klassischen Pendeltürsysteme. Frei wählbarer Duscheinstieg – Türöffnung nach innen oder nach außen – ergänzt mit praktischer Hebe-Senk-Funktion beim Öffnen und Schließen der Tür(en). Zusätzlicher Vorteil: Die flächenbündige Glasbefestigung sorgt für optimalen Pflegekomfort.

The further development of classic double-action door systems. Freely selectable shower entrance – door opening inwards or outwards, supplemented by a practical lift-lower-function when opening and closing the door(s), and optimum ease of care thanks to countersunk glass fixings on the inside of the shower.

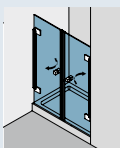

105



110W/P



200W/P

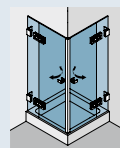

220W/P

Hier sehen Sie nur eine kleine Auswahl möglicher Einbauvarianten. Alle mit dem System realisierbaren Einbausituationen finden Sie ab Seite 67.

Here are a few installation examples. All realizable system installation situations see from page 67.

BH 2401

Pendeltürsystem

- nach innen/außen öffnend
- Hebe-Senk (+/-5 mm)
- selbstschließend ab 90°
- inkl. Anschlagsschutz
- Verschraubungen verdeckt
- versetzte Glaskanten

Double-action door system

- inward/outward opening
- lift-lower (+/-5 mm)
- self-closing from 90°
- integrated impact protector
- concealed screw connections
- offset glass edges



1



2



3

1 Band Glas/Glas 180°
hinge glass/glass 180°

2 flächenbündige Glasbefestigung
countersunk glass fixing

3 Winkel Glas/Wand 90°
bracket glass/wall 90°





FALTTÜRSYSTEME FOLDING DOOR SYSTEMS



Falлтүrsysteme erlauben selbst in kleineren Bädern einen großzügigen Duscheinstieg. Die beweglichen Glastürflügel lassen sich komplett an die Wand parken und schaffen so einen optimal barrierefreien Zugang zur Dusche. Vorteil: mehr Raumgewinn, mehr Bewegungsfreiheit und eine großzügige Optik auch bei Nichtbenutzung der Dusche.

Folding door systems allow a generous shower entrance even in smaller bathrooms. The movable glass door panels can be parked completely against the wall and thus create optimal barrier-free access to the shower. Advantage: more space, more freedom of movement and a generous appearance even when the shower is not in use.

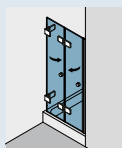

400(ü)

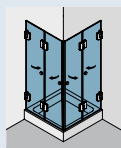

420

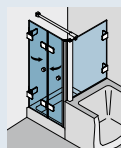

431W(ü)

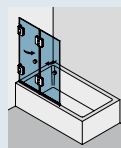

470

Hier sehen Sie nur eine kleine Auswahl möglicher Einbauvarianten. Alle mit dem System realisierbaren Einbausituationen finden Sie ab Seite 68.

Here are a few installation examples. All realizable system installation situations see from page 68.

BF 112

Falt-/Pendeltürsystem

- nach innen/außen öffnend
- großzügiger Duscheinstieg
- Band Glas/Glas ohne Federmechanismus
- Band Glas/Wand mit einstellbarer Nullstellung
- Verschraubungen verdeckt

Folding-/Double-action door system

- inward/outward opening
- wide shower entry
- hinge glass/glass without spring mechanism
- hinge glass/wall with adjustable zero positioning
- concealed screw connections



1



2



3

1 Band Glas/Glas 180°
hinge glass/glass 180°

2 Band Glas/Glas 180° (innen)
hinge glass/glass 180° (inside)

3 auf Badewanne (geöffnet)
on bathtub (open)

BF 112 XL

Falt-/Pendeltürsystem

- nach innen/außen öffnend
- großzügiger Duscheinstieg
- Band Glas/Glas ohne Federmechanismus
- Band Glas/Wand mit einstellbarer Nullstellung
- Verschraubungen verdeckt

Folding-/Double-action door system

- inward/outward opening
- wide shower entry
- hinge glass/glass without spring mechanism
- hinge glass/wall with adjustable zero positioning
- concealed screw connections



1



2



3

1 Band Glas/Wand
hinge glass/wall

2 Band Glas/Glas 180°
hinge glass/glass 180°

3 auf Badewanne (geöffnet)
on bathtub (open)



BF 134

Falt-/Pendeltürsystem

- nach innen/außen öffnend
- großzügiger Duscheinstieg
- Band Glas/Glas ohne Federmechanismus

Folding-/Double-action door system

- inward/outward opening
- wide shower entry
- hinge glass/glass without spring mechanism



1 Band Glas/Glas 180°
hinge glass/glass 180°

2 Band Glas/Glas 180° (innen)
hinge glass/glass 180° (inside)

3 auf Badewanne (geöffnet)
on bathtub (open)

BO 450

Faltdürsystem

- nach innen öffnend
- großzügiger Duscheinstieg
- durchgehende Dichtungen an allen Glaskanten
- Verschraubungen verdeckt

Folding door system

- inward opening
- wide shower entry
- continuous seals along all glass edges
- concealed screw connections



1 Band Glas/Wand
hinge glass/wall

2 Band Glas/Glas 180°
hinge glass/glass 180°

3 flächenbündige Glasbefestigung
countersunk glass fixing



Bild: © Odenwaldglas

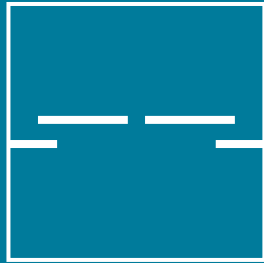

SCHIEBETÜRSYSTEME SLIDING DOOR SYSTEMS



Schiebetürsysteme werden schon immer gerne gewählt, weil sie leicht zu bedienen sind und für den Einstieg auch keine Raumtiefe beanspruchen. So eignen sie sich ideal für kleine Bäder, aber auch für Großraumduschen, im Objektbereich ebenso wie im Privatbad. Diese bedienerfreundlichen Systeme eignen sich auch hervorragend als Badewannenaufsatz.

Sliding door systems have always been a popular choice because they are easy to operate and do not require any room depth for entry. This makes them ideal for small bathrooms, but also for large-capacity showers, in commercial and private bathrooms. These user-friendly systems are also suitable for excellent bathtub attachments.

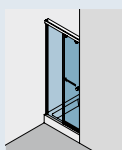

300(ü)

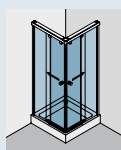

320(ü)

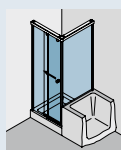

331(ü)

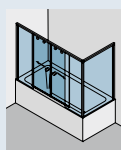

380(ü)BW

Hier sehen Sie nur eine kleine Auswahl möglicher Einbauvarianten. Alle mit dem System realisierbaren Einbausituationen finden Sie ab Seite 68.

Here are a few installation examples. All realizable system installation situations see from page 68.

SO 730

Schiebetürsystem

- sichtbare Laufwagen (mit Glasbearbeitung)
- Glasüberlappung 40 mm
- Wand- und Deckenmontage
- wandseitig auch ohne vertikale Profile (auf Wunsch)

Sliding door system

- visible slide units (with glass preparation)
- overlap, glass elements 40 mm
- wall and ceiling fixing
- sidewall without vertical profiles (upon request)



1



2



3

1 Deckenmontage
ceiling fixing

2 Schiebetürlaufwagen (außen)
sliding door unit (outside)

3 Schiebetürgriff
sliding door knob





SCHIEBETÜRSYSTEME MIT DÄMPFUNGS- UND EINZUGSFUNKTION SLIDING DOOR SYSTEMS WITH DAMPING AND SELF-CLOSING FUNCTION

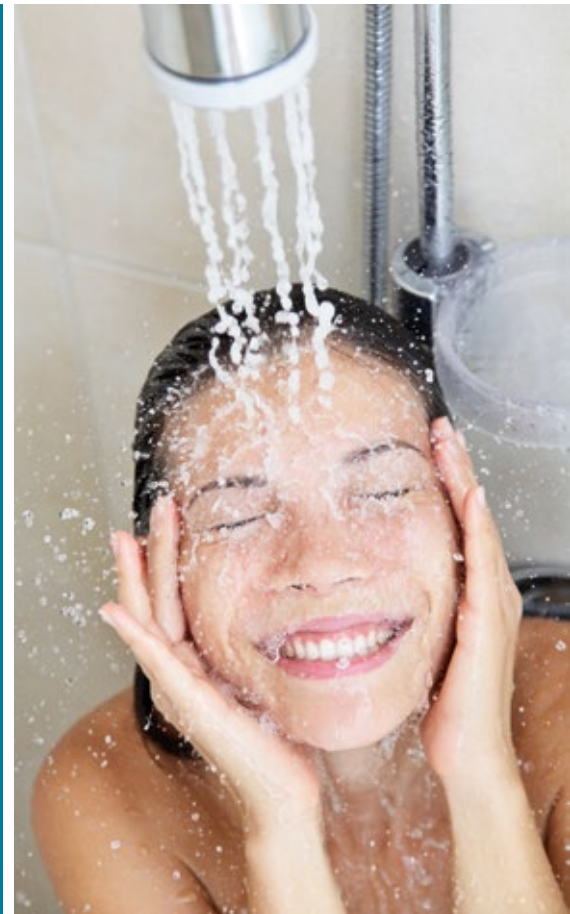

Mit der Dämpfungs- und Einzugsfunktion wird der Bedienkomfort von Schiebetürsystemen weiter gesteigert. Sowohl beim Öffnen als auch beim Schließen werden die Türflügel sanft und leise gebremst; ohne Aufprall und ohne Zurückfedern werden sie in die Endposition eingezogen. Diese bedienerfreundlichen Systeme eignen sich auch hervorragend als Badewannenaufsatz.

The damping and self-closing function further increases the ease of use of sliding door systems. Both when opening and closing, the door panels are quietly and gently braked; without impact and without springing back, they are retracted into the end position. These user-friendly systems are also suitable for excellent bath tub attachments.

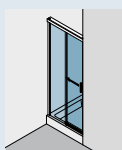

300(ü)

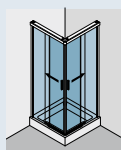

320(ü)

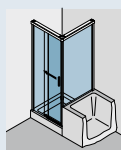

331(ü)

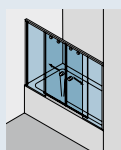

375(ü)BW

Hier sehen Sie nur eine kleine Auswahl möglicher Einbauvarianten. Alle mit dem System realisierbaren Einbausituationen finden Sie ab Seite 68.

Here are a few installation examples. All realizable system installation situations see from page 68.

SF 740 PREMIUM

Schiebetürsystem

- verdeckte Klemmlaufwagen (ohne Glasbearbeitung)
- beidseitige Dämpfung inkl. beidseitiger Einzugsfunktion
- teilbare Bodenführung **3**
- Glasüberlappung 40 mm
- Wand- und Deckenmontage

Sliding door system

- concealed clamp-type carriers (no glass preparation)
- damping and self-closing on both door sides
- separable floor guide **3**
- overlap. glass elements 40 mm
- wall and ceiling fixing



1 Deckenmontage
Ceiling fixing

2 vormontierte Funktionselemente
pre-fitted functional elements

3 einfache Reinigung
easy cleaning





WALK-IN SYSTEME WALK-IN SYSTEMS



Frei begehbbare Walk-In-Duschen ohne Tür mit flacher Duschtasse oder bodeneben gefließt, erfreuen sich ob ihrer klaren, zurückhaltenden Wirkung großer Beliebtheit. Großzügig und leicht heben sie die Trennung zwischen Dusche und restlichem Bad auf. Ob als einzelne Trennwand oder als komplexere Überecksituation, der einfache Zugang zur Dusche wird hier besonders geschätzt.

Freely accessible walk-in showers without doors, with a flat shower tray or tiled at floor level are very popular because of their clear, restrained effect. Generously and easily they eliminate the separation between shower and rest of the bathroom. Whether as a single partition wall or as a more complex corner situation, the easy access to the shower is especially appreciated here.

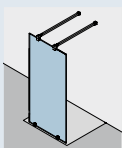

500

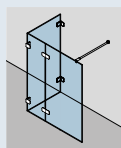

515

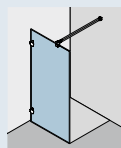

530W/P

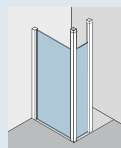

535

Hier sehen Sie nur eine kleine Auswahl möglicher Einbauvarianten. Alle mit dem System realisierbaren Einbausituationen finden Sie ab Seite 69.

Here are a few installation examples. All realizable system installation situations see from page 69.

WINKEL BRACKET

Walk-In – Einzeltrennwand (530W)

- frei begehbar, türenlos
- Stabilität durch Wandbefestigung
- großzügiger Duscheinstieg
- barrierefrei
- beliebige Glasabmessungen

Walk-in – Single partition (530W)

- freely accessible, no doors
- wall fixing for stability
- barrier-free compatible
- spacious shower entry
- variable glass dimensions



beschlagsabhängig
dependent on fittings



1



2



3

1 Winkel Glas/Wand 90°
bracket glass/wall 90°

2 Haltestange (eckig)
support bar (rectangular)

3 Haltestange (rund)
support bar (round)

PROFIL PROFILE

Walk-In – Einzeltrennwand (530P)

- frei begehbar, türenlos
- Stabilität durch Wandbefestigung
- großzügiger Duscheinstieg
- barrierefrei
- beliebige Glasabmessungen

Walk-in – Single partition (530P)

- freely accessible, no doors
- wall fixing for stability
- barrier-free compatible
- spacious shower entry
- variable glass dimensions



1



2



3

1 Wandprofil
wall profile

2 Haltestange (eckig)
support bar (rectangular)

3 Haltestange (rund)
support bar (round)



PO 570

Walk-In System

- frei begehbar, türenlos
- Stabilität durch Wand-/ Deckenbefestigung
- großzügiger Duscheinstieg
- barrierefrei
- beliebige Glasabmessungen

Walk-in system

- freely accessible, no doors
- wall/ceiling fixing for stability
- spacious shower entry
- barrier-free compatible
- variable glass dimensions



1



2



3

1 Deckenbefestigung
ceiling fixing

2 Bodenanschluss
ground connection

3 Wandprofil
wall profile

VARIANT

Walk-In – individuelle Lösungen

- frei begehbar, türenlos
- Stabilität durch Wandbefestigung
- großzügiger Duscheinstieg
- barrierefrei
- beliebige Beschlagsauswahl
- beliebige Glasabmessungen

Walk-in – individual solutions

- freely accessible, no doors
- wall fixing for stability
- barrier-free compatible
- spacious shower entry
- free choice of fittings
- variable glass dimensions



beschlagsabhängig
dependent on fittings



1



2



3

1 Winkel Glas/Wand 90°
Bracket glass/wall 90°

2 Winkel Glas/Glas 90°
Bracket glass/glass 90°

3 Lasche Glas/Glas 180°
Connector glass/glass 180°



Winkel-Einzeltrennwand | Bracket single partition Typ(e) 530W

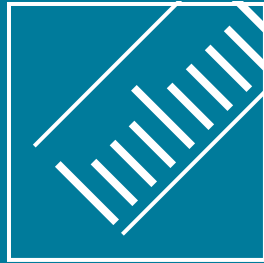

SONDERLÖSUNGEN SPECIAL SOLUTIONS

Besondere Raumsituationen erfordern besondere Duschlösungen. Ob im privaten oder öffentlichen Einsatzbereich gral überzeugt auch hier mit einer großen Variantenvielfalt. Sprechen Sie uns an. Folgend ein paar Anwendungsbeispiele.

Extraordinary room situations require specialized shower solutions. Regardless if in a private or public solution, gral provide a convincing variation to suite all needs. Feel free to contact us. Following some application situations.

BF 134

Pendeltürsystem – Eckdusche an Wanne

- nach innen/außen öffnend
- Türbeschläge mit Federmechanismus
- selbstschließend ab 20°
- Seitenteil innen bündig mit Badewannenaußenkante **1**

Double-action door system – Corner shower on bathtub

- inward/outward opening
- door fittings with spring mechanism
- self-closing from 20°
- side panel inside flush with outer edge of bathtub **1**



1 Band Glas/Wand
hinge glass/wall

2 Band Glas/Glas 90°
hinge glass/glass 90

3 Winkel Glas/Wand 90°
bracket glass/wall 90°

BF 134

Pendeltürsystem – T-Beschläge für Duschtüren

- nach innen/außen öffnend
- T-Band Glas/Glas 90°/180° mit Federmechanismus
- Beschläge für Türflügel und Trennwände
- selbstschließend ab 20°

Double-action door system – T-Fittings for shower doors

- inward/outward opening
- T-Hinge glass/glass 90°/180° with spring mechanism
- fittings for door panels and partition walls
- self-closing from 20°



1



2



3

1 T-Band Glas/Glas 90°/180°
T-Hinge glass/glass 90°/180°

2 Winkel Glas/Wand 90°
bracket glass/wall 90°

3 Sonderlösung geöffnet
special solution, opened

BF 134

Pendeltürsystem – T-Winkel für Duschfestteile

- nach innen/außen öffnend
- T-Winkel Glas/Glas 90°/180°
- Beschläge für Festteile und Trennwände

Double-action door system – T-Fittings for fixed panels

- inward/outward opening
- T-Bracket glass/glass 90°/180°
- fittings for fixed panels and partition walls



1



2

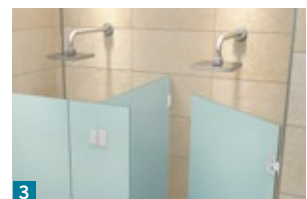

3

1 T-Winkel Glas/Glas 90°/180°
T-bracket glass/glass 90°/180°

2 Band Glas/Wand 90°
hinge glass/wall 90°

3 Sonderlösung geöffnet
special solution, opened

BO 410/415

Anschlagtürsystem – Eckdusche auf Mauerwerk

- nach außen öffnend
- für 135° Anwendungen
- Band Glas/Wand mit Anschraubflasche außen **2**

Single-action door system – Corner shower on wall

- outward opening
- for 135° applications
- hinge glass/wall with reversible external fixing plate **2**

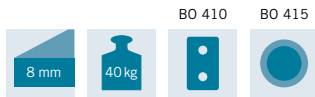

1



2



3

1 Band Glas/Glas 135°
hinge glass/glass 135°

2 Sonderl. Band Glas/Wand 135°
special hinge glass/wall 135°

3 Vierkantprofil + Magnetdichtung
square profile + magnetic seal

BO 415

Anschlagtürsystem – Eckdusche an Mauervorsprung

- nach außen öffnend
- Band Glas/Wand mit Anschraubflasche außen **1**
- Winkel Glas/Wand mit Anschraubflasche außen **2**

Single-action door system – Corner shower on wall

- outward opening
- hinge glass/wall with reversible external fixing plate **1**
- bracket glass/wall with reversible external fixing plate **2**



1



2



3

1 Sonderlösung Band Glas/Wand
special hinge glass/wall

2 Sonderl. Winkel Glas/Wand 90°
special brackets glass/wall 90°

3 Haltestange Glas/Wand
support bar glass/wall

SO 730

Schiebetürsystem – Walk-In Dusche

- raumsparend
- großzügiger Duscheinstieg
- Deckenstütze und Querverstrebung für optimale Stabilität **1**

Sliding door system – Walk-In shower

- space saving
- wide shower entry
- ceiling support and cross connection for optimum stability **1**



1



2



3

1 Deckenstütze + Querverstrebung
ceiling support + cross connection

2 Schiebetürlaufwagen (außen)
sliding door unit (outside)

3 Schiebetürgriff
sliding door knob

SO 730

Schiebetürsystem – Eckdusche an Mauervorsprung

- raumsparend
- optimierter Duscheinstieg, Schiebetür verläuft hinter die Wandvorsprung **1**
- Sonderbearbeitung des Laufrahmenprofils **2**

Sliding door system – Corner shower on wall

- space saving
- optimized shower entry, sliding door runs behind wall projection **1**
- slide frame profile with special preparation **2**



1



2



3

1 optimierter Duscheinstieg
optimised shower entry

2 Laufrahmenprofil (innen)
slide frame profile (inside)

3 Schiebetürlaufwagen (außen)
sliding door unit (outside)

SO 730

Schiebetürsystem – Dusch-/WC-Lösung

- raumsparend
- T-Sonderlösung
- einflügelige Schiebetür
- wahlweise Dusch- oder WC-Bereich geschlossen
- für Privat- und Objektbäder

Sliding door system Shower-/WC-Solution

- space saving
- T-special solution
- single sliding door
- shower or WC area optionally closed
- for privat and commercial bathrooms



1



2



3

1 WC-Bereich offen
WC area open

2 Dusch-Bereich offen
shower area open

3 Schiebetürlaufwagen (außen)
sliding door unit (outside)

SF 740 PREMIUM

Schiebetürsystem – Dusch-/WC-Lösung

- raumsparend
- Eck-Sonderlösung
- Profil-Mittelpfosten für Kabinenverbindung 2
- für Privat- und Objektbäder

Sliding door system Shower-/WC-Solution

- space saving
- corner-special solution
- profile middle post for cubicle connection 2
- for privat and commercial bathrooms



1



2



3

1 blickdicht (RAL 9005)
opaque (RAL 9005)

2 Profil-Mittelpfosten
profile middle post

3 großzügige Einstiege
wide entries



Bild: © Duschenschneiderei

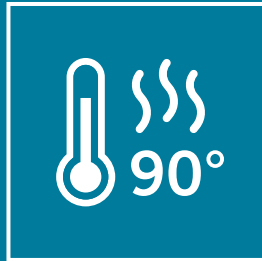

SAUNALÖSUNGEN SAUNA SOLUTIONS

Mit BF 112 lassen sich klassische Saunakabinen bis hin zu größeren Saunalandschaften realisieren. Mit transparenten Glaselementen wird jeder Spa hell, einladend und zur Wohlfühl-oase.

With the BF 112, classic sauna cabins up to larger sauna landscapes can be realized. With transparent glass elements every spa becomes bright, inviting and feel-good oasis.

Pendeltürsystem

- nach innen/außen öffnend
- Türbeschläge mit Federmechanismus
- einstellbare Nullstellung
- selbstschließend ab 20°
- geeignet bis 90° (Heißluft)
- Verschraubungen verdeckt

Double-action door system

- inward/outward opening
- door fittings with spring mechanism
- adjustable zero positioning
- self-closing from 20°
- suitable up to 90 degrees (hot air)
- concealed screw connections

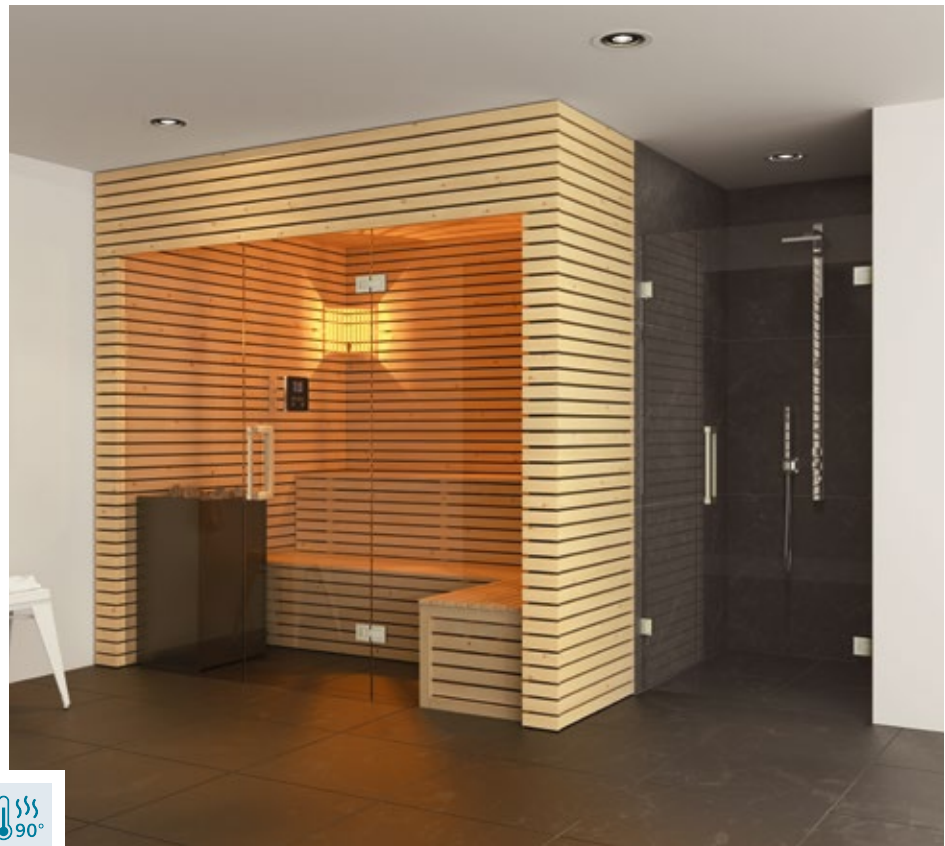

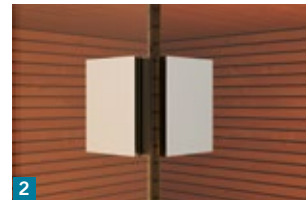

- 1 Band Glas/Wand
hinge glass/wall
- 2 Winkel Glas/Glas 90°
Bracket glass/glass 90°
- 3 Band Glas/Glas 180°
hinge glass/glass 180°



SONDEROBERFLÄCHEN SPECIAL SURFACES



Mit einer außergewöhnlichen Vielfalt an Oberflächen-Varianten setzt gral neue Trends im Badezimmer.

Offering an exceptionally broad range of surface finishes, gral sets new trends in bathroom styling.

Ob matt oder glänzend, poliert oder unpoliert, stylisch oder klassisch: Wählen Sie Struktur und Farbwirkung ganz nach Ihrem persönlichen Geschmack und Einrichtungsstil.

Matt, brilliant shine, polished, unpolished, modern or classic: the choice is yours – simply match the texture and color of our fixtures and fittings to your personal tastes and interior design requirements.

➔ Weitere Informationen zur »Colour Edition« auf www.gral-systeme.de.

Further information regarding »Colour Edition« on www.gral-systeme.de.



BF 112, Kupfer unpoliert ohne Anlaufschutz (rechts)
Achtung: Die Oberfläche läuft mit der Zeit individuell an (siehe unten).

BF 112, copper unpolished without PVD (right)
Attention: The surface changes appearance with time individual (see below).





BF 112, Smoke Chrom
BF 112, smoke chrome



SF 740, Schwarz matt,
RAL 9005 pulverbeschichtet
SF 740, black matt,
RAL 9005 powder coated

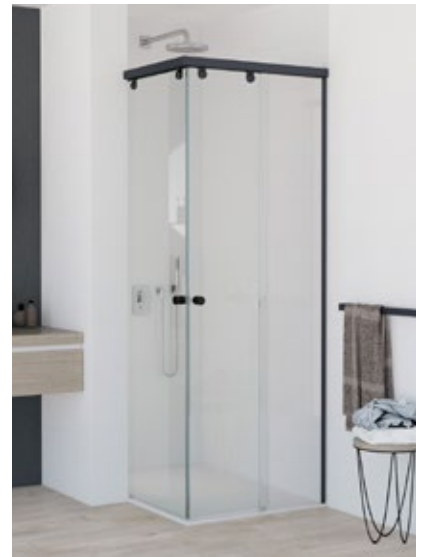

SO 730, Grey line, pulverbeschichtet
SO 730, Grey line, powder coated

Sonderoberflächen am Beispiel BF 112 | Special surfaces – exemplified by the BF 112 range



1



2



3



4



5



6



7



8



9



10

Achtung: Die Oberflächen **3**, **4** und **7** laufen mit der Zeit an (siehe Beispiel Seite 42).

Attention: The surfaces **3**, **4** and **7** changes appearance with time individual (see example page 42).

- 1 Smoke Chrom
smoke chromed
- 2 Grey line, pulverbeschichtet
Grey line, powder coated
- 3 Messing matt, gebürstet*,
o. Anlaufschutz
brass matt, brushed*,
without PVD
- 4 Messing poliert, o. Anlaufschutz
brass polished, without PVD
- 5 Schwarz matt, RAL 9005
pulverbeschichtet
black matt, RAL 9005
powder coated
- 6 Schwarz glänzend, RAL 9005
pulver-beschichtet
black polished, RAL 9005
powder coated
- 7 Kupfer unpoliert, o. Anlaufschutz
copper unpolished, without PVD
- 8 Altkupfer*
old copper*
- 9 Vibrant Bronze, gebürstet*
vibrant bronze, brushed*
- 10 Roségold*
rose gold*

* nur auf Anfrage | only on request

ZUBEHÖR & DETAILS ACCESSORIES & DETAILS

- Türgriffe und -Knöpfe
- Haltestangen
- Handtuchhalter
- Dichtprofile | Spritzschutz
- Verbauung ohne Dichtungsprofil
- Aluminiumprofile
- Door handles and knobs
- Support bars
- Towel Bars
- Sealing profiles | Splashguards
- Construction without sealing profiles
- Aluminium profiles

Für nahezu jede Duschsituation die richtigen Dicht-/Schwallschutzprofile, Magnetdichtungen und Wasserabweiser, sowie das umfangreiche Aluminiumprofilprogramm. Dazu passendes Zubehör wie Griffe, Handtuchhalter, Haltestangen, Glasablagen im runden oder quadratischen Design.

The range that offers the right sealing/anti-flooding profiles, magnetic gaskets and water deflectors together with a comprehensive range of aluminum extrusions. A comprehensive range of accessories like handles, towel holders, support bars, glass shelf in rectangular or square design.



Z-Laschen für Badewannen-Seitenteilfixierung

Z-Connector for bathtub side element fixation



Dreiecksglas | Triangle glass



TÜRGRIFFE UND -KNÖPFE DOOR HANDLES AND KNOBS

Mit einer großen Palette an Türgriffen und -knöpfen bietet Gral Gestaltungsfreiheit. Wie Schmuckstücke bringen die Griffvarianten das individuelle Einrichtungskonzept im Bad auf den Punkt und sorgen auf

ergonomische Weise für einen sicheren Ein- und Ausstieg.

Tipp: Horizontal montierte Stangengriffe bieten als Handtuchstange einen praktischen Zweitnutzen.

gral's extensive portfolio of rails, handles and knobs offers more scope for creative design. Like jewels, the various fittings add flair to any individual bathroom concept while also ensuring

the ergonomics required for safe cubicle entry and exit.

Tip: A horizontal pull bar can always double up as a handy towel rail.





Türknoopf rund, beidseitig
Door knob round, both sides



Türknoopf rund (Diabolo), beidseitig
Door knob round (diabolo), both sides



Türknoopf Trapez, beidseitig
Door knob trapez, both sides



Schiebetürgriff rund, beidseitig
Sliding door knob round, both sides



Schiebetürknoopf Trapez, beidseitig (außen)
Sliding door knob trapez both sides (outside)



Schiebetürgriffmuschel (außen)
Sliding door pull grip (outside)



Falлтürknoopf Trapez, Gummianschlag einseitig
Folding door knob trapez, buffer one side



Türgriff eckig BF 112, beidseitig
Door handle rectangular BF 112, both sides



Türgriff soft edge, beidseitig
Door handle soft edge, both sides

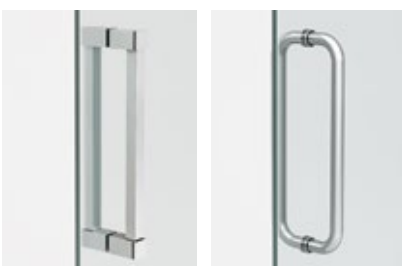

Türgriff eckig/rund, beidseitig
Door handle rectangular/ round, both sides



Türgriff eckig, einseitig
Door handle rectangular, one side



Schiebetürgriffleiste eckig, SF 740 (außen)
Sliding door handle rectangular, SF 740 (outside)

HALTESTANGEN SUPPORT BARS

Sicherer Halt für elegante Glasduschen: Ob rund oder eckig im Design, ob für Decken- oder Wandmontage oder speziell für Dach-schrägen – unsere Stabilisationssysteme sind auf jede Raumsituation verwendbar. Das garantiert gut gesicherten, unbeschwerten Duschgenuss.

Secure mountings for elegant glass shower cubicles: Whether round or angular in design, whether for ceiling installation or wall fixing, and especially for sloping roofs – our systems offer excellence in design and stability in any room situation. And that means super-safe, care-free showering enjoyment.



Haltestange rund
Support bar round



Haltestange eckig
Support bar rectangular



Deckenanschluss rund
Ceiling installation round



Gelenk-Haltestange rund,
mit einstellbarem Anbindungs-
winkel

Support bar round,
with adjustable fixing angle



Gelenk-Haltestange rund,
mit einstellbarem Anbindungs-
winkel und T-Verbinder

Support bar round, with adjustable
fixing angle and T-Connection



Gelenk-Haltestange eckig,
mit einstellbarem Anbindungs-
winkel

Support bar rectangular,
with adjustable fixing angle



Gelenk-Haltestange eckig,
mit einstellbarem Anbindungs-
winkel, auch für Dachschrägen
geeignet

Support bar rectangular, with
adjustable fixing angle, suitable
for diagonal roof



Haltestangen rund oder eckig
für Rund- und Fünfeck-Duschen

Support bar round or rectangular
for curved showers and pentangu-
lar showers



Kurze Gelenk-Haltestange rund,
mit einstellbarem Anbindungs-
winkel

Short support bar round,
with adjustable fixing angle



HANDTUCHHALTER TOWEL BARS

Formvollendet präsentiert sich Funktionales und macht im Alltag Freude: Die Handtuchstangen im runden oder eckigen Design, lassen sich wie die filigrane Punkt-halter innen flächenbündig montieren. Der Pluspunkt ist somit eine einfache Reinigung. So schön kann Praktisches sein.

With *gral*, the functional takes on fabulous form, making each morning shower a delight. The towel rails of round or rectangular design offer all the intricacy of flush button mounting on the inside, with the added benefit of easy cleanability. Practical and beautiful at the same time.





Handtuchstange eckig | Towel rail rectangular



Handtuchstange rund, innen flächenbündig | Towel rail round, countersunk



Handtuchstangen wahlweise doppel-
seitig oder innen flächenbündig
Towel rail optionally back-to-back
or countersunk

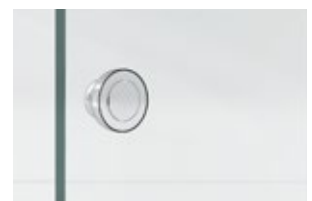

Handtuchhalter innen flächen-
bündig
Countersunk towel knob

DICHTPROFILE | SPRITZSCHUTZ SEALING PROFILES | SPLASHGUARDS

Glasduschen sind keine Aquarien. Passgenaue eingesetzte Dicht- und Spritzschutzprofile gewährleisten eine optimale Abdichtung. Magnetdichtungen an den Glasstürkanten sorgen für leises und millimetergenaues Schließen.

A Glass shower cubicle is not an aquarium. Exact-fitting gasket extrusions and spray-protection profiles ensure optimum water containment, while magnetic seals on the glass door edges ensure quiet closing with millimeter accuracy.





Schlauchdichtung
Soft nose seal



Vierkantprofil, durchgehende
Magnetdichtung | Square profile,
continuous magnetic seal



Magnetdichtung 180° für Pendel-
türen | Magnetic seal 180° for
double-action doors

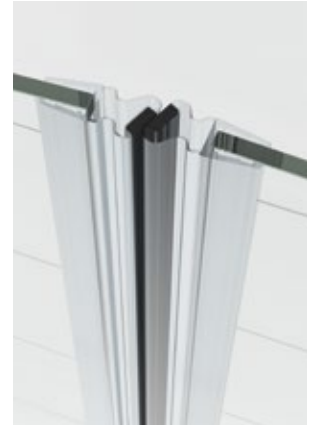

Universalmagnetdichtung
Universal magnetic seal



Magnetdichtung 90°
Magnetic seal 90°



Magnetdichtung 90°, Aluminium
Magnetic seal 90°, aluminium



Anschlagdichtung 90°
Rebate seal 90°



Magnetdichtung 90° für Pendel-
türen | Magnetic seal 90° for
double-action doors



Wasserabweiser
Water disperser



Wasserabweiser mit Alu-Schwall-
schutzprofil | Water disperser with
aluminium splashguard profile



Wasserabweiser mit Acryl-Schwall-
schutzprofil | Water disperser with
acrylic splashguard profile



Wasserabweiser mit Acryl-Schwall-
schutzprofil | Water disperser with
acrylic splashguard profile

VERBAUUNG OHNE DICHTPROFILE CONSTRUCTION WITHOUT SEALING PROFILES

Klarheit auf ganzer Linie verspricht eine Verbauung ohne Dichtprofile, die bei bestimmten baulichen Voraussetzungen realisierbar ist. Mit der Beschlagserie

BF 112 lassen sich die Spaltmaße auf ein Minimum reduzieren. Die pure, höchästhetische Optik begeistert Designfreunde.

Assembly without additional sealing profiles – available subject to certain structural requirements – creates clean, clear design lines. With the BF 112, for example, gap

dimensions can be reduced to an absolute minimum, creating a pure, highly aesthetic appearance that will always please those with an eye for excellence.

Verbauung **ohne** Dichtprofile (wandseitig 3 mm Spaltmaß)
Construction **without** sealing profiles (wall side 3 mm clearance)

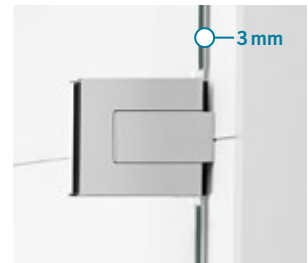

Verbauung **mit** Dichtprofil (wandseitig 11 mm Spaltmaß)
Construction **with** sealing profiles (wall side 11 mm clearance)





Bodenebene Verbauung mit Gefälle:
Durch die eingerückte Tür läuft das Spritzwasser vom Glas in die Dusche.

Floor-level installation with a slope: With the door inset, spray water from the glass flows back into the shower.

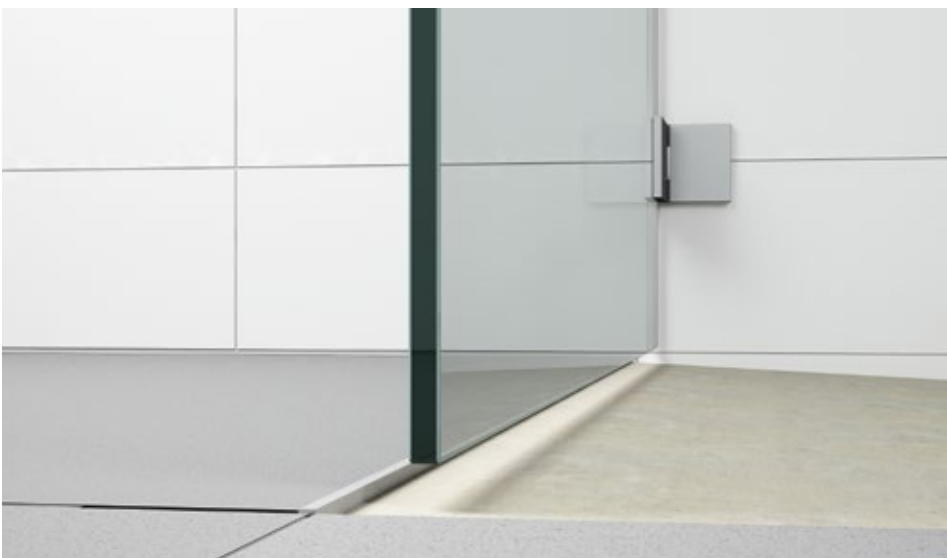

Abgesenkter Boden mit Gefälle:
Auch hier läuft das Spritzwasser vom Glas in den Duschbereich.

Sunken floor with slope: Here again, spray water from the glass flows back into the shower.



Einbausituation mit Duschtasse:
Durch die eingerückte Tür verbleibt das Wasser auch ohne Dichtprofil im Duschbereich.

Installation with shower tray: With the door inset, the water remains in the shower area even without a sealing profile.

ALUMINIUMPROFILE ALUMINIUM PROFILES

Sanft schimmerndes Aluminium beweist im Zusammenspiel mit Glas in der Badarchitektur Klasse. Mit dem umfangreichen Aluminiumprofilprogramm nimmt nahezu jede Idee rund um zeitgemäße Duschsysteme Gestalt an.

In combination with glass, softly shimmering aluminum exudes class in bathroom architecture. With an extensive range of aluminum extrusions, even the most ambitious design ideas for modern shower styling can be realized.



Deckenbefestigung (PO 570)
Ceiling fixing (PO 570)



Mittelpfosten-Verbindung 90°
(PO 570)
Middlepost-connection 90°
(PO 570)



Schiebetür-Laufrahmenprofil (SO 730)
Slide frame profile for sliding doors (SO 730)



Schiebetür-Laufrahmenprofil (SO 730-Sonder)
Slide frame profile (SO 730 special)



Schiebetür-Laufrahmenprofil (SF 740)
Slide frame profile (SF 740)



Deckenmontage Schiebetürsystem (SF 740)
Ceiling fixing Sliding door system (SF 740)



Schiebetür-Laufrahmenprofil (SF 740)
Slide frame profile (SF 740)



Deckenmontage Schiebetürsystem (SF 740)
Ceiling fixing Sliding door system (SF 740)



Klemmprofil mit eckigem Abdeckprofil
Clamp profile with angular cover profile



Klemmprofil mit abgerundetem Abdeckprofil
Clamp profile with curved cover profile

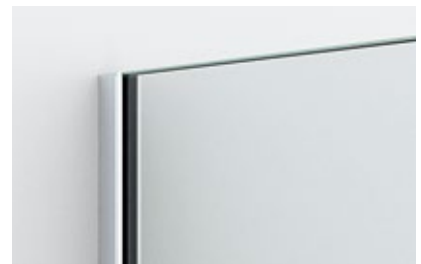

U-Profil
U-profile



Aufsatzprofil und Magnetleistenträger
Attachment profile and magnetic support profile



Eckprofil 90° (für Glas/Glas Verbindungen)
Corner profile 90° (for glass/glass connections)



Vierkantprofil (Aufnahme für Kunststoffprofil)
Square profile (holder for acrylic profile)

PRODUKTZERTIFIZIERUNG
DIN EN 14428
PRODUCT CERTIFICATION
EN 14428

Alle gral Duschbeschlagserien (Basismaterial Messing) sind Qualitätsprodukte. Produktzertifizierungen unterstützen Sie bei der Bewerbung und Planung bis zur finalen Objektrealisation.

gral shower hinge series (basic material brass) are all of high quality. Product certifications will help you beginning of promotion and planning till to final object realisation.

gral Duschsysteme und Beschlagserien sind gemäß der europäischen DIN EN 14428 (CE-Kennzeichnung) auf Stabilität, Dauerhaftigkeit und Dichtigkeit erfolgreich getestet.

gral shower systems and hinge series are tested according to the European EN 14428 (CE marking) of Stability, durability and water-tightness.



Zu jedem Duschsystem steht eine Konformitätserklärung zur Verfügung. Die montagefertigen Bausätze für maßgefertigte Duschen entsprechen in der Komposition ihrer Elemente garantiert den getesteten Systemen.

A Declaration of Conformity is available for each shower system. The installation-ready assembly kits for tailor-made showers are guaranteed to conform to the tested systems in terms of make-up and technology.

→ Alle Konformitätserklärungen auf www.gral-systeme.de

All Certificates of Conformity on www.gral-systeme.de

DIN EN 14428

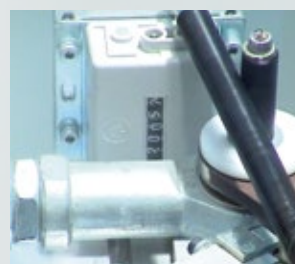
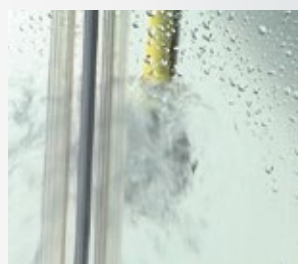
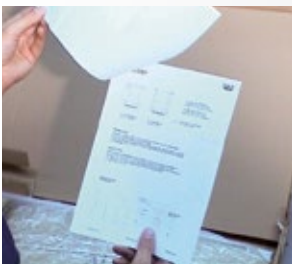

AUSSTELLUNGSMODULE DEMONSTRATION MODULES

- Musterkoffer
- Tischfunktionsmuster
- Mobiler Präsenter
- Sample case
- Desktop Demo Units
- Mobile Presentation Unit

Ob beim Kunden vor Ort, bei Präsentationen oder in Ihrer Ausstellung – die Produkte selbst sind Ihre besten Argumente im Beratungs- und Verkaufsgespräch. Nutzen Sie dazu unsere verschiedenen Ausstellungsmodule.

Whether at the customer's site, at presentations or at your own exhibition – the products themselves are your best arguments in consultations and sales negotiations. So make the most of our range of display modules!

Musterkoffer | Sample case

Hochwertiger Musterkoffer aus Aluminium zur Präsentation einzelner Duschbeschlagskomponenten.

High-quality sample case off aluminium for presentation of single shower hinge components.



Art.-Nr. | Art. No. 8.77.995.999.99
Preis netto | Price net 500,00 €



Inhalt frei definierbar

Definieren Sie maximal 10 Produktkomponenten in gewünschter Oberfläche aus dem gesamten Produktportfolio (>10 Stück auf Anfrage). Artikel und Oberflächen lt. Preisliste

Content free definable

Define maximum 10 product components in desired surface from the entire product portfolio (>10 pieces on request). Article and range of surfaces as price list

Tischfunktionsmuster I Desktop Demo Units

Ideal für Produktpräsentationen, technische Schulungen, wo die Funktionen der Duschbeschläge im eingebauten Zustand dargestellt werden. Komplett montiert, einfaches Handling. Perfekt als zusätzliches Ausstellungsmodul im Showroom.

For product presentations and technical training courses where the functions of the shower fittings need to be demonstrated in their installed condition. Completely assembled, easy to use. Ideal as an additional exhibition module in the showroom.



Art.-Nr. und Serien siehe gral Preisliste I Art. No., and Series see gral price list – Preis netto I Price net 170,00 €

Mobiler Präsenter I Mobile Presentation Unit

Das bewegliche Ausstellungsmodul zur Präsentation individueller Ganzglasduschen. Verfügbar in Basisfarbe Schwarz/Weiß. Maximale Darstellung von vier verschiedenen Band-System-/Serien. Bestückung nach Wunsch. Wir beraten Sie gerne bei der Produkt-Zusammenstellung.













The wheeled demonstration module for presentation of individual glass shower systems. Available in basic colour black/white. Maximum representation of four different hinge-system-/series. Assembly on request. We will be glad to assist you in your product compilation.



Geeignet für jede gral Duschbeschlagsreihe
Suitable for all gral shower fitting series

Abmessung (B×T×H)
Dimension (W×D×H)
1250 × 1250 × 2252 mm

Preis netto I Price net
inkl. Glas I incl glass 1950,00 €
optional ohne Glas I
optionally without glass 1780,00 €

										
										
Duschsystem shower system	BO 112	BO 410	BO 415	BO 450	BH 112	BH 200	BH 205	BH 210	BH 250	BH 255
Basismaterial basic material	Messing Brass	Messing Brass	Messing Brass	Messing Brass	Messing Brass	Messing Brass	Messing Brass	Messing Brass	Messing Brass	Messing Brass
DIN EN 14428 DIN EN 14428	■	■	■	■	■	■	■	■	■	■
max. Tragfähigkeit (2 Bänder) max. loading capacity (2 hinges)	40 kg	40 kg	40 kg	36 kg	40 kg	40 kg	36 kg	50 kg	36 kg	36 kg
max. Türbreite bei Türhöhe von 2.000 mm (bei vorgeschriebener Glasstärke) max. door width with door height of 2.000 mm (on prescribed glass thickness)	1.000 mm (8 mm)	1.000 mm (8 mm)	1.000 mm (8 mm)	900 mm (8 mm)	1.000 mm (8 mm)	1.000 mm (6/8 mm)	1.000 mm (6 mm) 900 mm (8 mm)	1.200 mm (8 mm)	1.000 mm (6 mm) 900 mm (8 mm)	1.000 mm (6 mm) 900 mm (8 mm)
frei begehbar, türenlos freely accessible, no doors	Typ(e) ■ 530 W/P	Typ(e) ■ 530 W/P	Typ(e) ■ 530 W/P	Typ(e) ■ 530 W/P	Typ(e) ■ 530 W/P	Typ(e) ■ 530 W/P	Typ(e) ■ 530 W/P	Typ(e) ■ 530 W/P	Typ(e) ■ 530 W/P	Typ(e) ■ 530 W/P
fluchtende + überlappende Bänder inline + overlapping hinges		■	■							
durchg. Dichtung (im Bandbereich) continuous seal (in hinge area)	■	■	■	■	■	■	■	■	■	■
optimiert zum Einbau ohne Dichtungen optimized or installation without seals										
einstellbare Nullstellung adjustable zero position										
selbstschließend self-closing					■	■	■	■	■	■
Soft-Einzug soft-closing										
Soft-Stop soft-stop										
verdeckte Wandbefestigung concealed wall fixing	■	■	■	■	■	■	■	■	■	■
flächenbündige Glasbefestigung countersunk glass fixing			■	■			■	■	■	
Wandbefestigung mit Langlöchern wall mount with elongated holes	■	■	■	■	■	■	■	■	Winkel Glas/Wand ■ Bracket glass/wall	Winkel Glas/Wand ■ Bracket glass/wall
mit gebogenen Türflügeln with curved door panels						■	■	■	■	

BF 111	BF 112/ 112 XL*	BF 134	BO 381	BH 2401	BF 112/ 112 XL*	BF 134	BO 450	SO 730	SF 740 PREMIUM	PO 570	VARIANT
Messing Brass	Messing Brass	Messing Brass	Messing Brass	Messing Brass	Messing Brass	Messing Brass	Messing/ Aluminium Brass/ Aluminium	Messing/ Aluminium Brass/ Aluminium	Messing/ Aluminium Brass/ Aluminium	Aluminium Aluminium	Messing/ Aluminium Brass/ Aluminium
■	■	■	■	■	■	■	■	■	■	■	■
40 kg	45 kg 60 kg*	40 kg	36 kg	40 kg	45 kg 45-60 kg*	40 kg	36 kg	40 kg	50 kg		
1.000 mm (8 mm)	1.000 mm (8 mm) 1.200 mm* (10 mm) 1.000 mm* (12 mm)	1.000 mm (8 mm) 800 mm (10 mm)	1.000 mm (6 mm) 900 mm (8 mm)	1.000 mm (8 mm)	1.000 mm (8 mm) 1.200 mm* (8 mm)	1.000 mm (8 mm)	900 mm (8 mm)	900 mm (8 mm)	1.250 mm (8 mm) 1.000 mm (10 mm)		
	Typ(e) ■ 530 W/P	Typ(e) ■ 530 W/P	Typ(e) ■ 530 W/P	Typ(e) ■ 530 W/P						■	■
			Band Glas/Glas ■ Hinge glass/glass		Band Glas/Glas ■ Hinge glass/glass	Band Glas/Glas ■ Hinge glass/glass	■	■	■		
	■				Band Glas/Wand ■ Hinge glass/wall						
■	■				Band Glas/Wand ■ Hinge glass/wall						
■	■	■		■					■		
									■		
									■		
	■	■	■	■	■	■	■				■
			■	■			■				(■)
	■	■	■	■	■	■	■				■
			■								

*Nur bei Verwendung von Türbeschlägen BF 112 XL Glas/Wand mit zusätzlichen Zwischenlagen für 8 mm Glas.
Only by using of door fittings BF 112 XL glass/wall with additional gaskets for 8 mm glass.

(■) beschlagsabhängig | series-dependent



ANSCHLAGTÜRSYSTEME SINGLE-ACTION DOOR SYSTEMS

BO 112

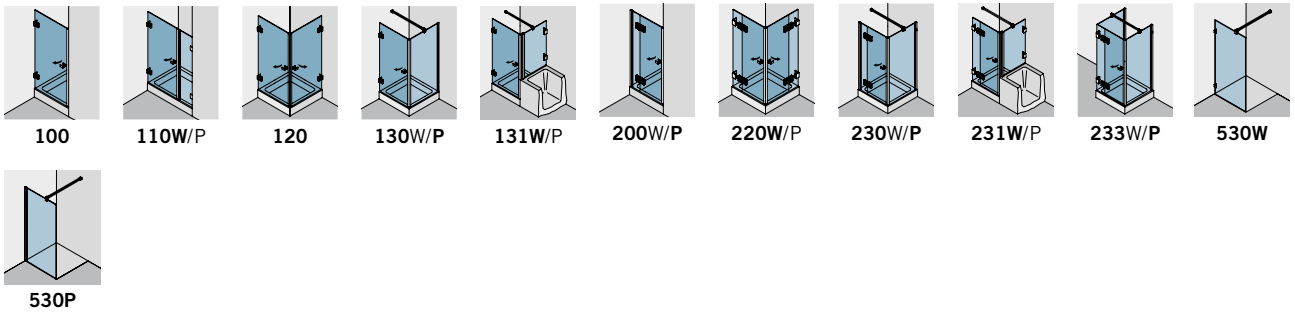

BO 410

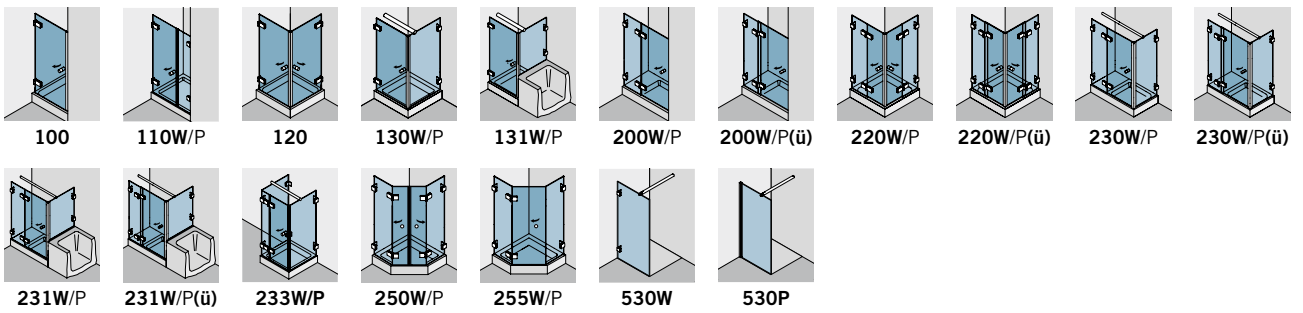

BO 415

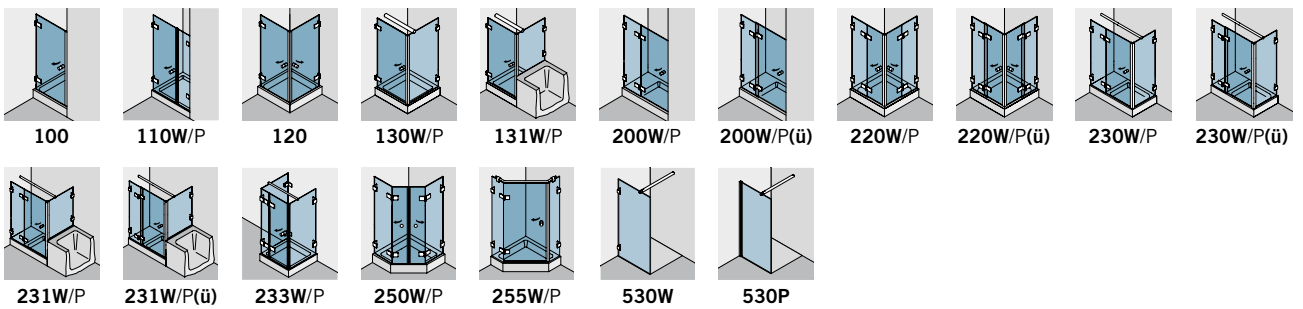

BO 450

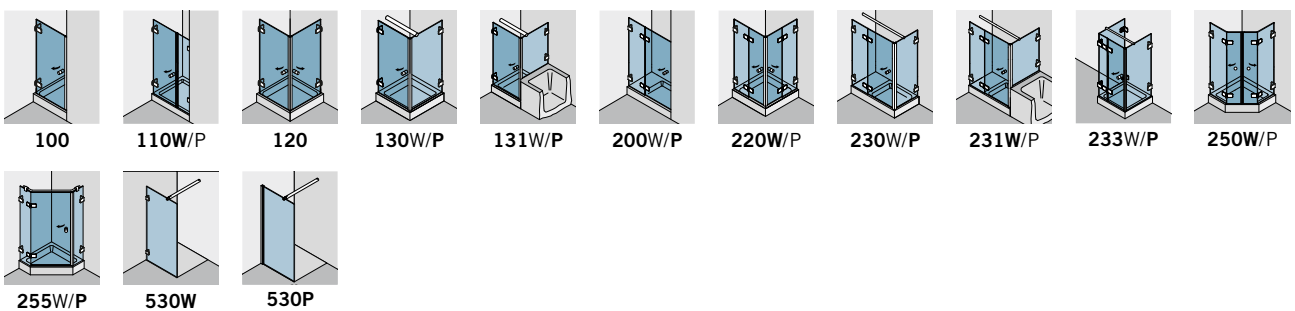

BH 112 mit Hebe-Senk-Funktion I with lift-lower-function

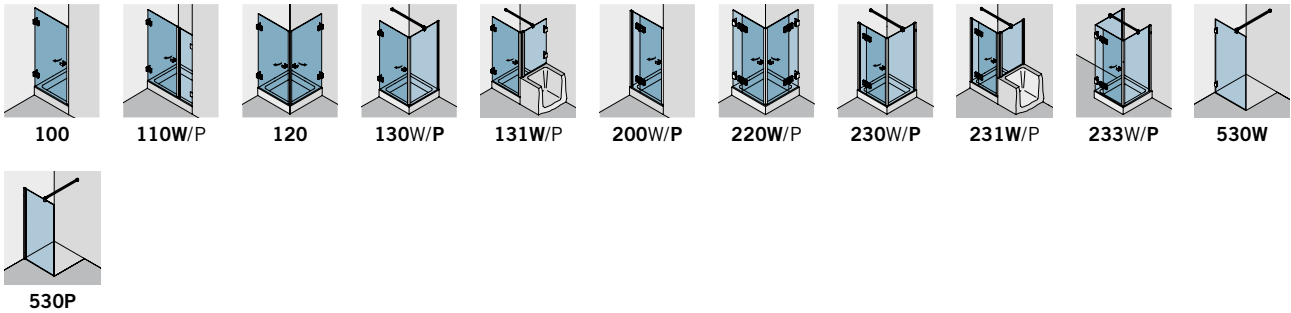

BH 200 mit Hebe-Senk-Funktion I with lift-lower-function

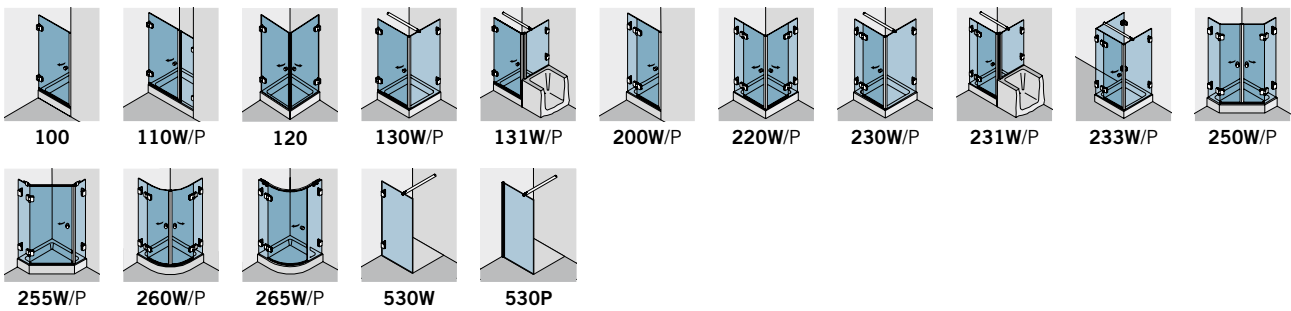

BH 205 mit Hebe-Senk-Funktion I with lift-lower-function

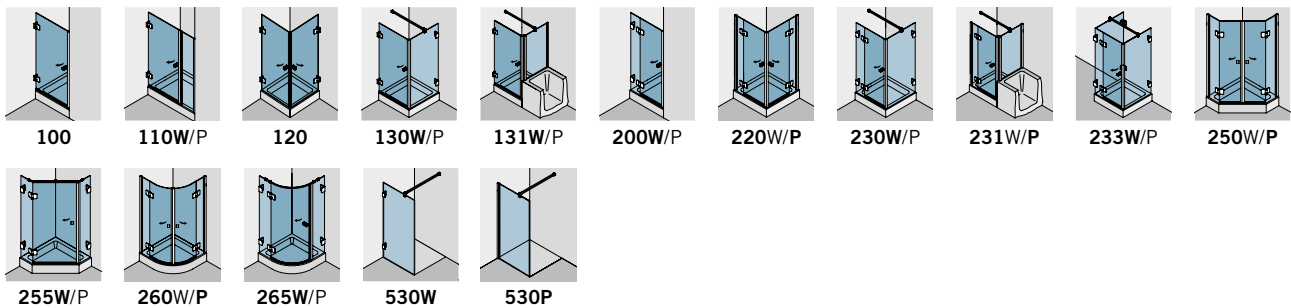

BH 210 mit Hebe-Senk-Funktion I with lift-lower-function

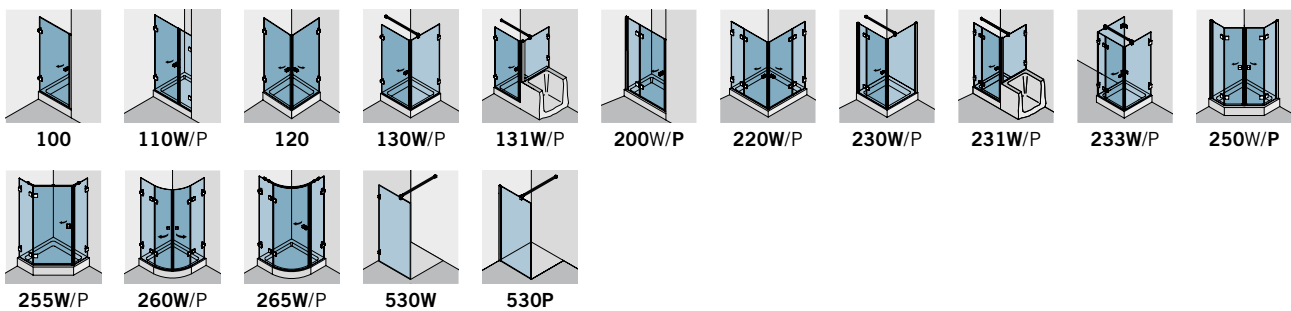

- W Fixteile werden mit Winkeln gehalten
fixed panels are held with brackets
- P Fixteile werden mit Profilen gehalten
fixed panels are held with profiles
- (ü) überlappende Glaselemente
overlapping glass elements



BH 250 mit Hebe-Senk-Funktion | with lift-lower-function

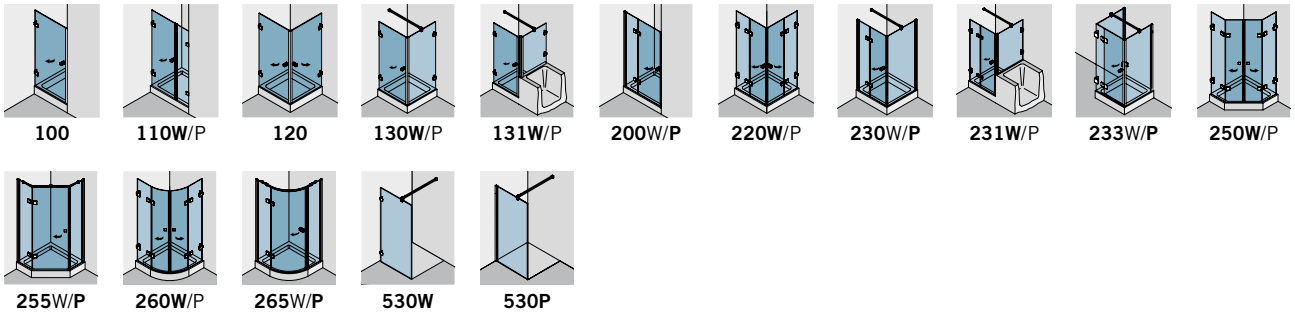

BH 255 mit Hebe-Senk-Funktion | with lift-lower-function

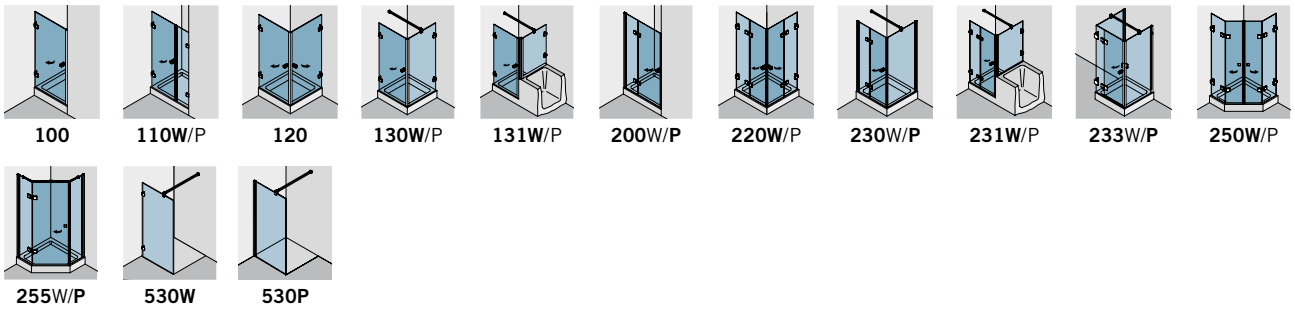

PENELTÜRSYSTEME
DOUBLE-ACTION DOOR SYSTEMS



BF 112

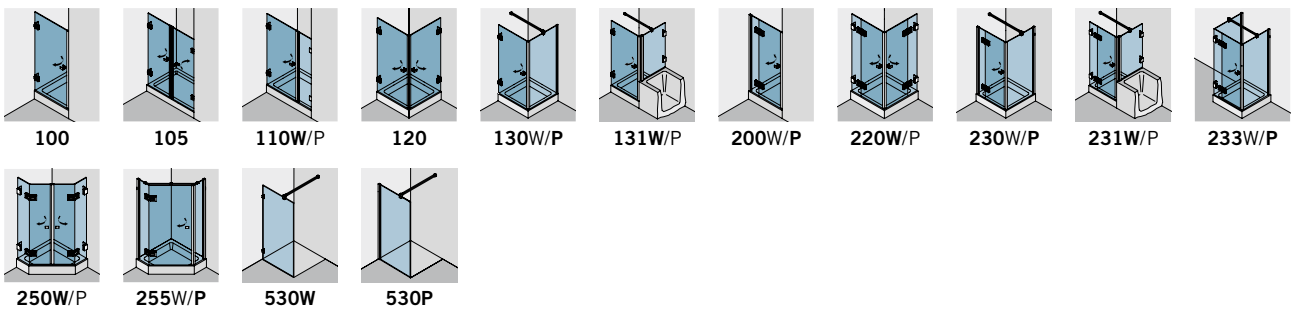

BF 112 XL

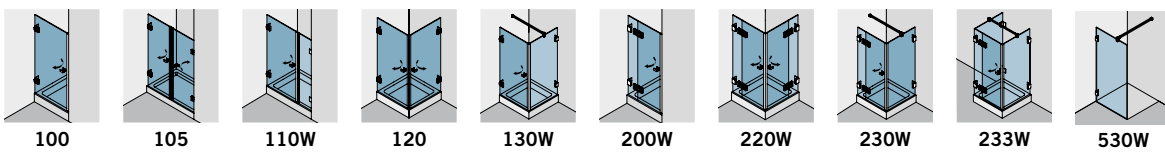

BF 134



BO 381

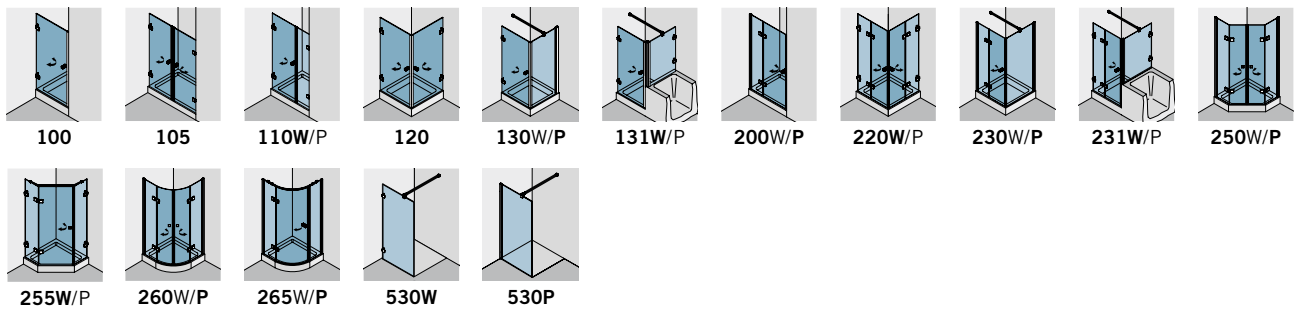

BH 2401 mit Hebe-Senk-Funktion | with lift-lower-function

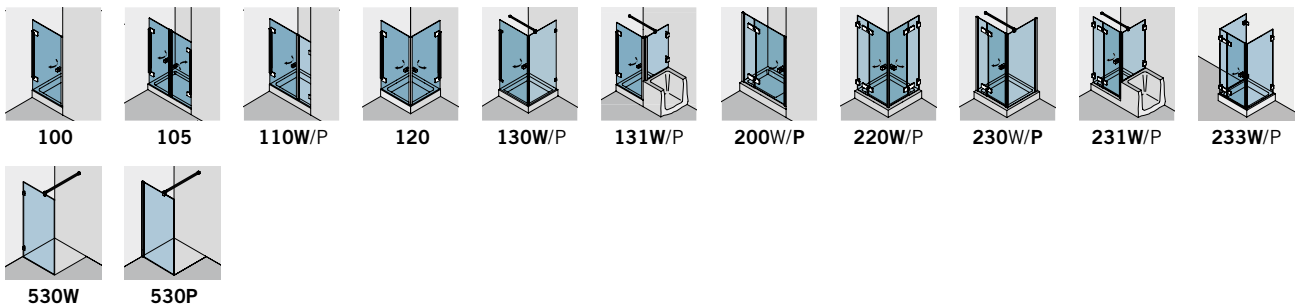

- W Fixteile werden mit Winkeln gehalten
fixed panels are held with brackets
- P Fixteile werden mit Profilen gehalten
fixed panels are held with profiles



FALTTÜRSYSTEME FOLDING DOOR SYSTEMS



BF 112

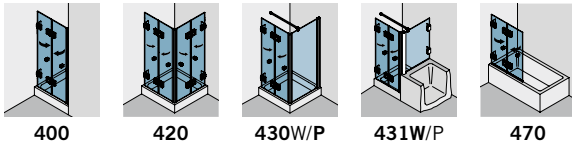

400

420

430W/P

431W/P

470



BF 112 XL

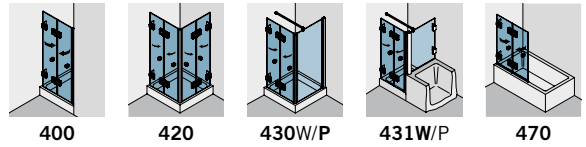

400

420

430W/P

431W/P

470



BF 134

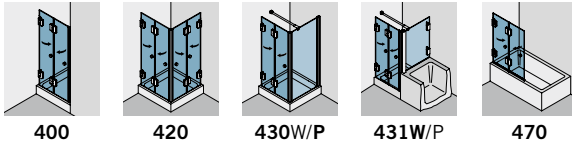

400

420

430W/P

431W/P

470



BO 450

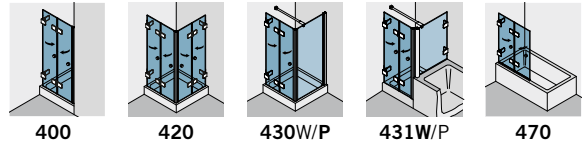

400

420

430W/P

431W/P

470



SCHIEBETÜRSYSTEME SLIDING DOOR SYSTEMS



SO 730

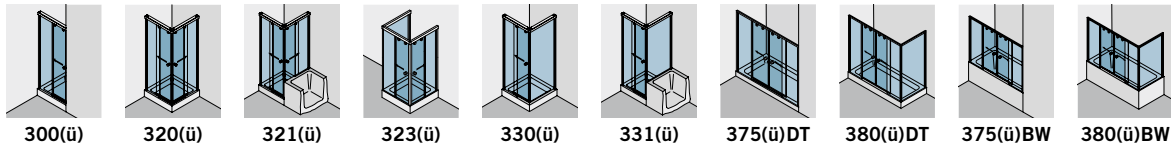

300(i)

320(i)

321(i)

323(i)

330(i)

331(i)

375(i)DT

380(i)DT

375(i)BW

380(i)BW



SF 740 PREMIUM mit Dämpfung- und Einzugsfunktion | with damping and self-closing function

Wandmontage | Wall Fixing

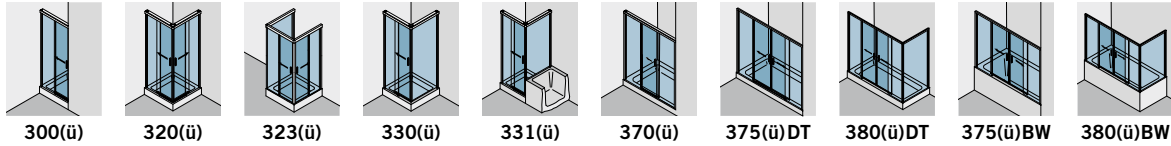

300(i)

320(i)

323(i)

330(i)

331(i)

370(i)

375(i)DT

380(i)DT

375(i)BW

380(i)BW

Deckenmontage | Ceiling fixing

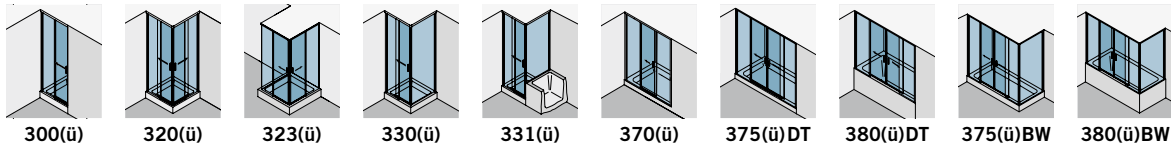

300(i)

320(i)

323(i)

330(i)

331(i)

370(i)

375(i)DT

380(i)DT

375(i)BW

380(i)BW



WALK-IN SYSTEME WALK-IN SYSTEMS

Winkel | Bracket

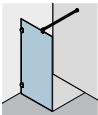

530W

Profil | Profile

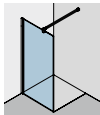

530P

PO 570 ohne/mit Bodenfreiheit | without/with ground clearance

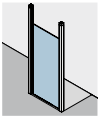

500

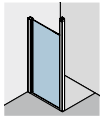

530

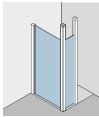

535

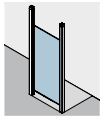

500

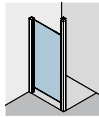

530

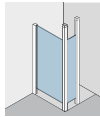

535

VARIANT

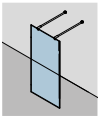

500

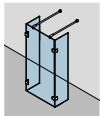

503

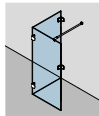

505

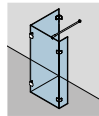

510

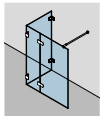

515

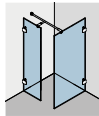

525

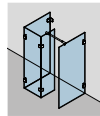

528

- W Fixteile werden mit Winkeln gehalten
fixed panels are held with brackets
- P Fixteile werden mit Profilen gehalten
fixed panels are held with profiles
- DT Duschtasse | Shower tray
- BW Badewanne | Bath tub
- (ü) überlappende Glaselemente
overlapping glass elements

E-SHOP & DUSCHENKONFIGURATOR

E-SHOP & SHOWER CONFIGURATOR

E-Shop

Mit dem gral E-Shop können Sie einfach und schnell Einzelkomponenten per Mausklick bestellen.

E-shop

With the gral e-shop all single components can be order easy and fast only with few clicks.

→ Sie erreichen den E-Shop auf www.gral-systeme.de
(Voraussetzung: User-Account)

You can access the e-shop on www.gral-systeme.de
(Supposition: user account)



Duschenkonfigurator

Mit dem gral Duschenkonfigurator können Sie mit wenigen Klicks alle Bestandteile Ihrer Glasdusche auswählen, die nötigen Informationen aufrufen sowie Daten und Ansichten für die Glasbearbeitung erstellen.

Für individuelle Lösungen haben Sie die Möglichkeit, Sondermaße und Sonderbearbeitungen einzugeben. Mit einem Klick geben Sie dann Ihre Bestellung auf.

→ Sie erreichen den Konfigurator auf www.gral-systeme.de
(Voraussetzung: User-Account)

You can access the configurator on www.gral-systeme.de
(Supposition: user account)

Shower configurator

With the gral shower configurator, you can select all the components of your glass cubicle, retrieve all the necessary information and generate data, views and elevations for the glass machining and preparation work – all in just a few clicks.

Special off-standard dimensions can also be entered to create individual solutions. Then one more click to send off your order, and there you have it.



- 1** Einbausituation und den passenden Modelltyp bestimmen
Determine the installation situation and model type
- 2** Beschlag und Oberfläche wählen
Select your fitting and surface
- 3** Grundelemente Ihrer Dusche definieren
Define the basic shower elements
- 4** Konfigurationsergebnis Standard Sets:
Configuration result, Standard Sets
- 5** Fertige Konfiguration dem Warenkorb hinzufügen und den Bestellvorgang abschließen
To complete the configuration, add your choices to the basket and complete the ordering procedure.

SEMINARPROGRAMM TRAINING PROGRAMM

»BEST IN SHOWERS«

In unserem Seminar »Best in Showers« haben Sie die Möglichkeit zu einem intensiven Informationsaustausch. Sie erhalten einen umfassenden Überblick des Produktportfolios, lernen den Bereich E-Commerce kennen, und erleben die Produkte hautnah zum Anfassen – nach Absprache auch in Ihrem Betrieb (»In your house«).

In our training program »Best in Showers« you have the possibility of an intensive information exchange. You will receive a comprehensive overview of our products plus learn how to use our E-Commerce tools both in theory and practice. If it is required, also in your company (»In your house«).



Das können Sie erwarten

- praxiserfahrene Referenten
- lebendige Kombination von Theorie/Praxis
- individuell zugeschnitten Inhalte
- Produkt-/Schulungszertifizierungen

You can expect the following

- specialists for training
- combination of theoretical and practical training
- individual customer contents
- Product/Training certificate

➔ Weitere Informationen auf www.gral-systeme.de

Further information on www.gral-systeme.de



**Gral Systeme GmbH
Niederlassung Rietberg**

Ludwig-Erhard-Straße 7
33397 Rietberg
GERMANY

Phone +49 (0) 5244 9076-0
Fax +49 (0) 5244 9076-219

www.gral-systeme.de